

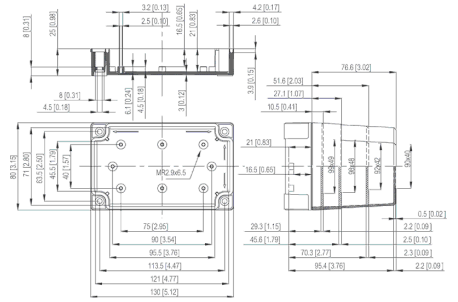

SAMPLE

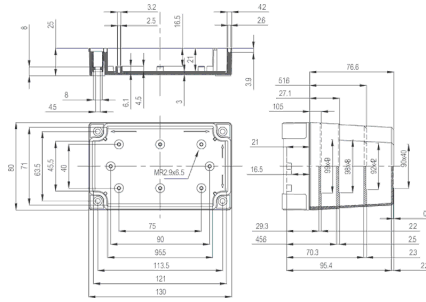

Product #: 6412901

Order Symbol: UL PC 100/35 LT

Description: 5.1 x 3.1 x 1.4 inch polycarbonate enclosure with grey cover

Dimensions	Height	Width	Depth
Inch	5.1	3.1	1.4
mm	130	80	35

Materials

Material:	Polycarbonate
Base color:	RAL 7035 -light grey
Cover color:	Transparent Grey
Gasket material:	Polyurethane

Temperatures

Temperature °F (short term):	-40 ... 250
Temperature °F (continuous):	-40 ... 175
Temperature °C (short term):	-40 ... 140
Temperature °C (continuous):	-40 ... 80

Ratings

Ingress Protection (EN 60529):	IP66; IP67
Impact Resistance (EN 62262):	IK08
Electrical insulation:	Totally insulated
Halogen free (DIN/VDE 0472, Part 815):	No
UV resistance:	UL 508
Flammability Rating:	UL94-5VA (f1)/ Cover: UL94-V0 (f1)
Glow Wire Test (IEC 60695):	960 °C
UL/cUL Type:	1, 4, 4x and 6;